

CANBUS Rugged Tablet PC ID83

Model : R12ID8M-RTM7CA

Intel® Atom Dual Core N2800 1.86GHz

Features:

- 12.1" High Quality 1024 x 768 Resolution LED Panel
- Intel® Atom Dual Core N2800 1.86GHz with Intel® Nm10 Chipset
- 1 x SODIMM, Max. 4GB DDR3 (Default 2GB)
- Alu-Mg Alloy Housing with Protection Rubber for MIL-STD-810G Shock, Vibration and Drop
- Built-in Wireless / Bluetooth and GPS module
- Support 2 channels isolated CANBUS and 1 COM port for RS 232, 1 x SIM card slot
- Ergonomic Design with Handstrip and Carry Belt Accessories (for Optional)
- 6cell, 5200mAh Lithium-Ion Battery Pack



Mechanical Design Drawings

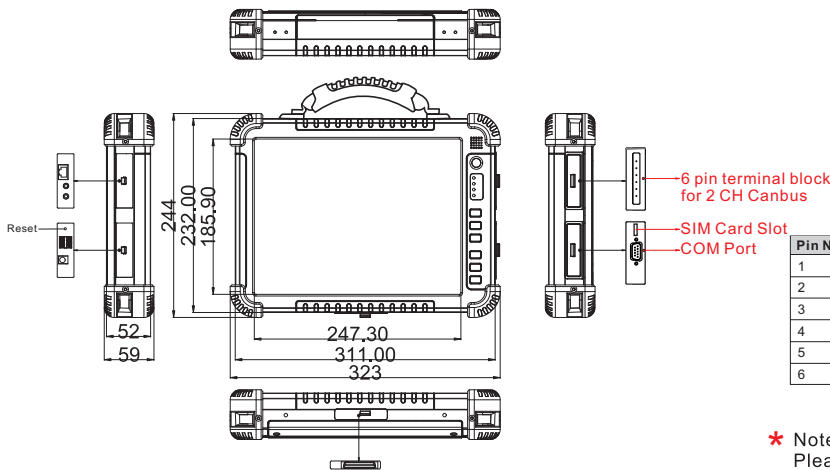

Pin No.	Symbol	Description
1	GND_ISO_A	A port Isolated Ground
2	CANL_1_CONN	A port CAN Bus Low-level
3	CANH_1_CONN	A port CAN Bus High-level
4	GND_ISO_B	B port Isolated Ground
5	CANL_2_CONN	B port CAN Bus Low-level
6	CANH_2_CONN	B port CAN Bus High-level

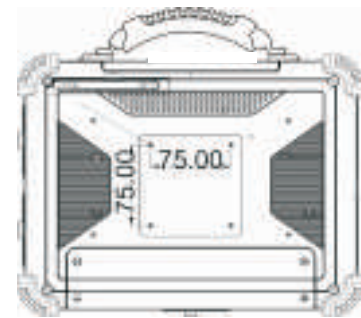

* Note: this is a simplified drawing and some components are not marked in detail. Please contact our sales representative if you need further product information.

System Specification

- Processor : Intel® Atom Dual Core N2800 1.86GHz
- BIOS : AMI System BIOS
- System Chipset : Intel® NM10 Chipset
- System Memory : 1 x SODIMM, Max 4GB DDR3 (Default 2GB)
- LAN Controller : 10/100/1000 LAN
- Storage : 64GB mSATA SSD (Default), (Max. up to 256GB)
- Audio : Audio out for headset, Micro in for microphone jack, 1.5W Speaker (Internal)

Wireless Communication

- WLAN & Bluetooth : 802.11a/b/g/n + 2T2R & Bluetooth 4.0+ Class I combo card (Default)
- WWAN : Built-in 3G module (Optional)
- GPS : U-Blox Neo-6Q

Mechanical and Environment

- Dimensions (W x L x H) : 311 x 232 x 52 mm
- Weight : 3Kg (w/o accessories)
- Operation Temperature : -20~60 (AC mode), -10~50 (Battery mode)
- Operation Humidity : 10% to 90% (non condensing)
- IP Proof : IP54
- Mounting : VESA mount, Vehicle mount
- Shock* : MIL-STD-810G M516.6
- Vibration* : MIL-STD-810G M514.6
- Drop* : MIL-STD-810G M516.6, 4 Ft, Free to Concrete
- Certifications : CE, FCC Class B, MIL-810G for Vibration / Shock / Drop / Temp.

Display Specification

- Pixel Number : 1024 x 768
- Brightness : 700cd/m² (typ.)
- Touch (Default) : 4 Wire Resistive

I/O Connectors

- Left I/O Port : 1 x LAN, 2 x USB 2.0, 1 x Audio out, Mic-in Jack, 1 x Power Input Jack, 1 x Reset Button
- Right I/O Port : 1 x 6 pin Terminal Block for 2 CH CANbus, 1 x COM port, 1 x SIM card slot
- Downside Docking : 1 x Docking connector for expansion 4x USB, and Docking Stand Power input

In front Control

- Control Button : 1x Menu Key control Brightness, Volume and Battery Status
- LED indicator : Power On/ Off, Battery, HDD Access, Wifi On / Off

Power Management

- Power input : 19V DC
- Power consumption : 12.5W typ.
- Battery : Li-Ion battery 5200mAh, 11.1V
- Battery Hour : 7 hrs*
- Adapter : 100-240V, 50-60Hz, 19V DC

*Note: Measured at dimming LCD brightness. Varies depending on the usage conditions, or when an external device is attached.